

EBAUCHES S. A.

NEUCHÂTEL

SWITZERLAND

Edited and published by Ebauches S. A.

(French, English, German, Italian, Spanish)

Copyright 1953 by Ebauches S. A.



LE LANDERON
BRANCH OF FONTAINEMELON WATCH FACTORY
LE LANDERON

$13\frac{3}{4}$ ''' **148**
31 mm

Recording chronograph
with adjustable hammer and minute heart

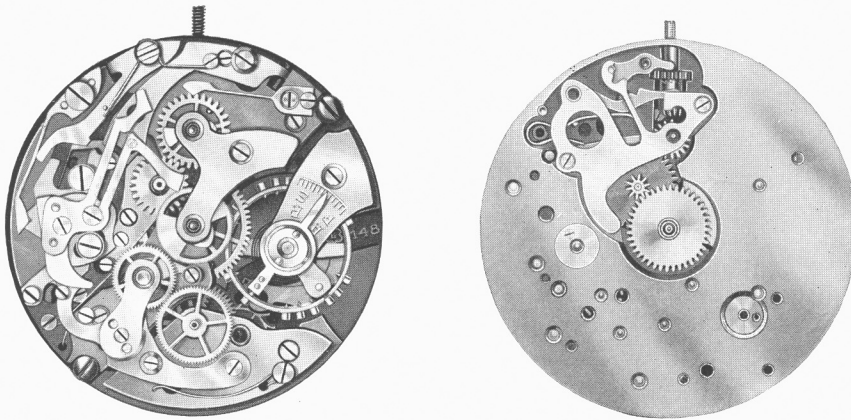

Enlarged movement

TECHNICAL AND PRACTICAL COMMUNICATION FOR THE GUIDANCE OF WATCH REPAIRERS

DISASSEMBLING :

1. Release mainspring by pressing on click indicated by arrow (hold back winding stem).
2. Remove balance wheel and pallet fork.
3. Remove fly-back lever spring 8340, holding it to prevent it from flying off, and fly-back lever 8180 (left-hand thread).
4. Remove operating lever 8139, after taking out its screw 58139 and its safety screw 58139¹ (with hammer 8220 pressing against the hearts).
5. Remove winding stem.
6. If the pushers are grooved, remove them before taking the movement out of the case; if the pushers are of the spring or lug type, remove the movement first and the pushers afterwards. Then, in either case, remove hands and dial.
7. Remove mounted coupling clutch 8080, after taking out its screw 58080 and its safety screw 58080¹, then remove driving wheel 8060 by means of a fork-shaped lever.
8. Remove hammer cam jumper 8356, then mounted hammer 8220, after taking out its 2 safety screws 58220¹.
9. Remove chronograph bridge 8500, mounted minute-recording runner 8020 and mounted chronograph runner 8000.
10. Remove mounted sliding gear 8100, after taking out its screw 58100, then remove minute-recording jumper 8270 and its screw 58270.
11. Remove coupling clutch spring 8320, sliding gear spring 8325 and friction spring 8290 of chronograph runner.
12. Remove reverser 8146 and its spring 8147.
13. Disassemble the movement and clean all its parts in the ordinary way.

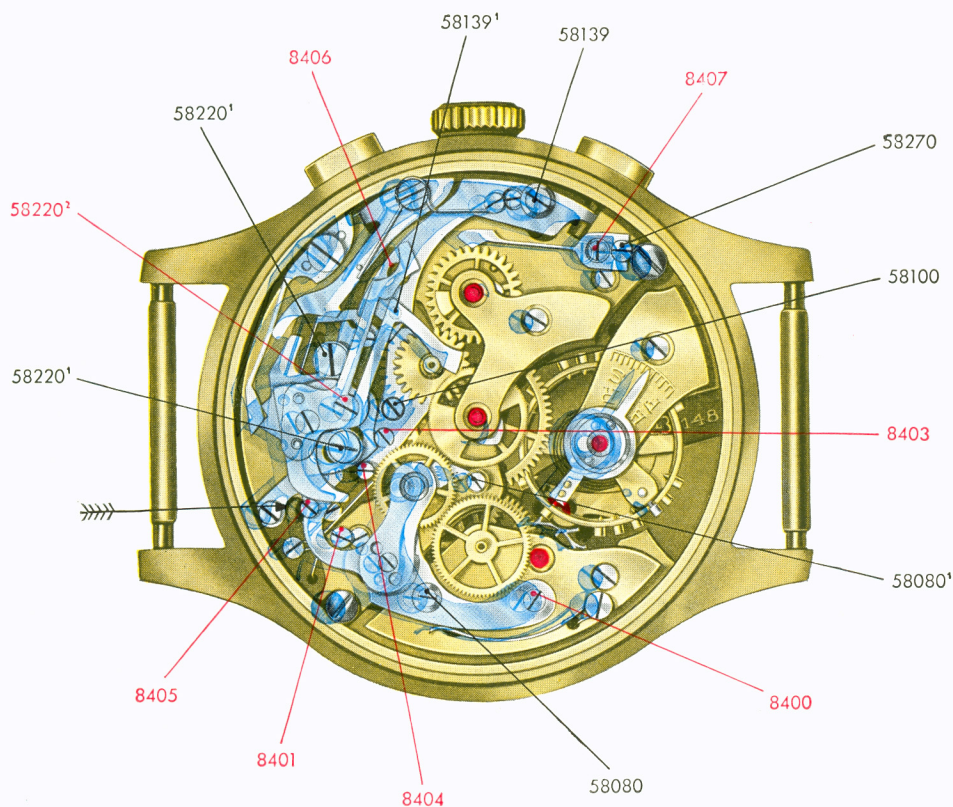

NOTE : In future, an additional slot will be cut in the heads of eccentrics (see illustration opposite), so that they may be easily distinguished from screws.

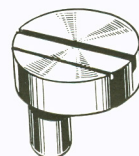

CHECKING A :

Check condition of finger and teeth of chronograph runner, coupling wheel and driving wheel. Remove bridge of coupling wheel, clean the bushings of the latter and see that both coupling and sliding gear wheels run freely. Also clean center wheel tube and see that the inner bushing is in position. Reassemble the watch movement proper, oil all runners and wind mainspring one turn and a half to check the running. It is advisable to remove the balance wheel before reassembling the chronograph mechanism.

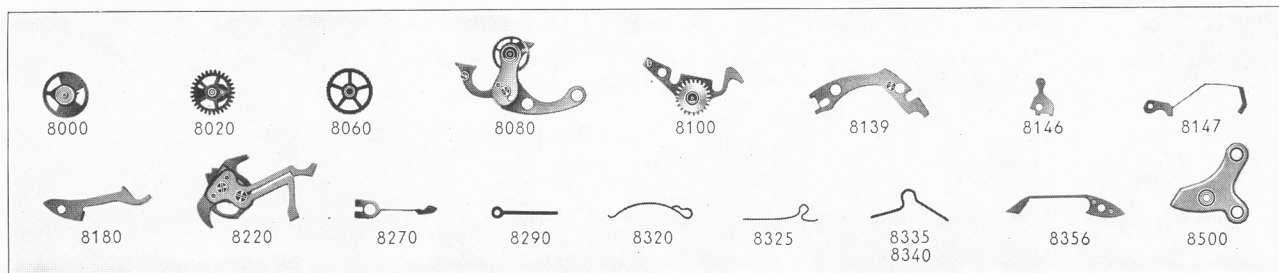

ASSEMBLING AND LUBRICATION :

1. Screw on friction spring 8290 and reverser spring 8147.
2. Fit mounted sliding gear 8100 and its screw 58100, then its spring 8325 (the sliding gear should move freely).
3. Replace mounted minute-recording runner 8020 and mounted chronograph runner 8000, after oiling the long pivot of the latter (make sure that friction spring 8290 exerts normal pressure under runner 8000), then replace chronograph bridge 8500.
4. Fit minute-recording jumper 8270 and its screw 58270; see that it is under slight tension.
5. Fit operating lever 8139, which should move freely under its screw 58139 and its safety screw 58139¹.
6. Fit reverser 8146, then mounted hammer 8220, which should move freely under its 2 safety screws 58220¹ (see that the pin fixed in the hammer cam works inside reverser spring 8147, and check the working of the latter). Fit hammer cam jumper 8356.
7. Fit fly-back lever 8180, which should move freely under its screw (left-hand thread) and its spring 8340.
8. Oil short pivot of mounted chronograph runner 8000 and both pivots of coupling wheel; then fit mounted coupling clutch 8080, which should move freely under its screw 58080 and its safety screw 58080¹, then fit coupling clutch spring 8320. (Never oil pivots of minute-recording runner or of sliding gear wheel.)
9. Fit driving wheel 8060, which should be flush with the coupling wheel.
10. Make sure that all runners are perfectly free-acting, then replace the balance wheel.

ECCENTRICS :

The purpose of an eccentric is to adjust the relative position of 2 parts of the mechanism. It differs from a screw (A) by its unthreaded shank, situated off the center, and by its tight, "push-in" fitting (B).

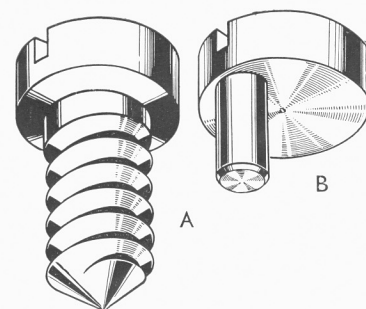

The required adjustment is made by giving the eccentric a slight turn to the left or right.

Number	Designation	Function
		For adjusting :
8400	eccentric for pivoting of coupling clutch	depth of gearing, coupling wheel / driving wheel
8401	banking eccentric for coupling clutch	depth of gearing, coupling wheel / chronograph runner wheel
8403	eccentric for pivoting of sliding gear	depth of gearing, sliding gear / recording runner wheel
8404	uncoupling eccentric for sliding gear	disengaging sliding gear / finger of chronograph runner, by hammer edge
8405	uncoupling eccentric for coupling clutch	disengaging coupling wheel / chronograph runner wheel, by hammer edge
8406	finger-depth eccentric	penetration of finger of chronograph runner into sliding gear toothing
8407	eccentric for minute-recording jumper	relative position of sliding gear wheel and finger, by minute-recording jumper
58220 ²	hammer-adjusting screw	inclination of hammer arms in contact with hearts, by cone shape of screw.

CHECKING B :

Check depth of gears and penetration of finger into sliding gear toothing. When operating the fly-back action through pressure of the hammer on the hearts, see that the chronograph runner is blocked; on the other hand, the minute-recording runner should have slight side-shake (the hammer does not weigh on the heart; adjustment may be completed by means of the adjustable heart of the minute-recording runner). Also make sure that the sliding gear is kept away from the finger, that the hammer arms do not foul the wheels or the bridge, and that uncoupling eccentric 8405 of the coupling clutch keeps the coupling wheel disconnected from the chronograph runner wheel (when the chronograph is working, disconnection should occur when the stop pusher is pressed for the first time). Slightly grease the hammer where it comes into contact with the hearts, hammer cam jumper, uncoupling eccentric 8404 of sliding gear, fly-back lever and uncoupling eccentric 8405 of coupling clutch.

CASING :

Spring or lug pushers should be placed in position before casing the movement, but grooved pushers should be placed in position after casing, by unscrewing the operating lever and fly-back lever. Then, in either case, replace the winding stem, fit the 2 case screws and check the working by means of the pushers. Fit the dial and the hour, minute and second hands, then, with the hammer pressed against the hearts by the zero-action pusher, fit the chronograph and minute-recording hands.

Description and numbering of spare parts according to the "Technological Dictionary of Watch Parts", 2nd edition.

100 Plate	425 Click	8146 Reverser
106 Barrel and train wheel bridge	430 Click spring	8147 Reverser spring
118 Combined bridge	435 Yoke (clutch lever)	8180 Fly-back lever
121 Balance cock for flat hairspring	440 Yoke spring (set spring)	8220 Hammer, mounted
125 Pallet cock	443 Setting lever (detent)	8221 Hammer stud
182 Barrel and cover (without arbor)	445 Setting lever spring (set bridge)	8270 Minute-recording jumper
195 Barrel arbor	450 Setting wheel	8290 Friction spring for chronograph runner
206 Center wheel and pinion	705 Escape wheel and pinion with straight pivots	8320 Coupling clutch spring
210 Third wheel and pinion	710 Jewelled pallet fork and staff	8325 Sliding gear spring
225 Fourth wheel and pinion, with 2 long pivots	714 Pallet staff	8335 Operating lever spring
245 Cannon pinion with clam notch	721 Balance with flat hairspring, regulated	8340 Fly-back lever spring
255 Hour wheel	723 Balance staff, pivoted	8356 Hammer cam jumper
260 Minute wheel	730 Roller	8400 Eccentric for pivoting of coupling clutch
301 Regulator for flat hairspring	770 Mainspring	8401 Banking eccentric for coupling clutch
311 Upper cap jewel, with end-piece, for balance	8000 Chronograph runner, mounted	8403 Eccentric for pivoting of sliding gear
330 Lower cap jewel with end-piece, for balance	8020 Minute-recording runner, mounted, 30 m.	8404 Uncoupling eccentric for sliding gear
401 Winding stem	8040 Minute-recording runner, mounted, 45 m.	8405 Uncoupling eccentric for coupling clutch
407 Clutch wheel	8060 Driving wheel	8406 Finger-depth eccentric
410 Winding pinion	8080 Coupling clutch, mounted	8407 Eccentric for minute-recording jumper
415 Ratchet wheel	8100 Sliding gear, mounted, 30 m.	8500 Chronograph bridge
420 Crown wheel	8120 Sliding gear, mounted, 45 m.	
423 Crown wheel core	8139 Operating lever	

(8335/8340 Spring with 2 functions)

5101 Case screw - 5106 Barrel bridge screw, high head - 5106¹ Barrel bridge screw, low head - 5118 Screw for combined bridge - 5121 Balance cock screw - 5125 Pallet cock screw - 5311 Upper end-piece screw - 5330 Lower end-piece screw - 5423 Crown wheel core screw - 5425 Click screw - 5430 Screw for click spring - 5443 Setting lever screw - 5445 Screw for setting lever spring - 5738 Hairspring stud screw - 5751 Dial key - 58080 Coupling clutch screw - 58080¹ Safety screw for coupling clutch - 58082 Coupling wheel bridge screw - 58100 Screw for sliding gear, 30 m. - 58120 Screw for sliding gear, 45 m. - 58139 Operating lever screw - 58139¹ Safety screw for operating lever - 58146 Reverser screw - 58147 Screw for reverser spring - 58180 Fly-back lever screw - 58220 Hammer screw - 58220¹ Safety screw for hammer - 58220² Hammer-adjusting screw - 58270 Minute-recording jumper screw - 58290 Screw for friction spring of chronograph runner - 58320 Screw for coupling clutch spring - 58335¹ Banking screw for operating lever spring - 58356 Hammer cam jumper screw - 58500 Chronograph bridge screw.

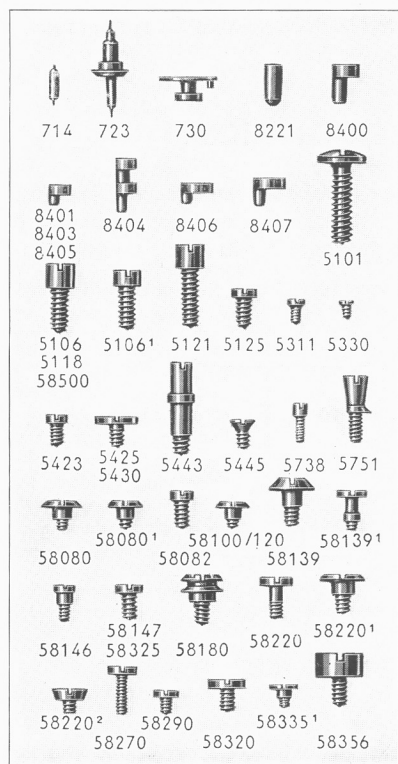
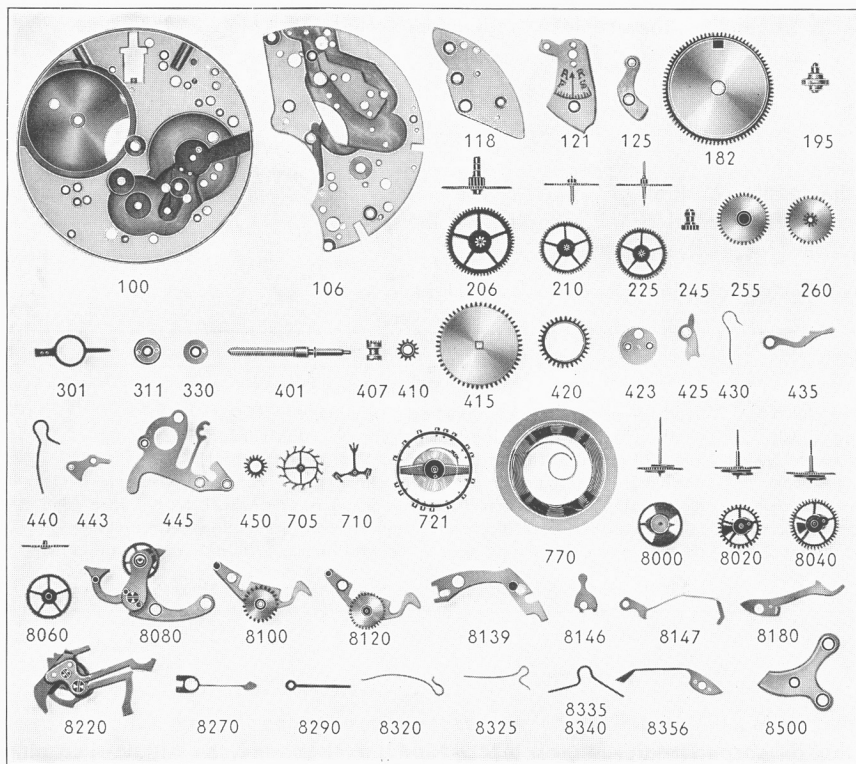

When ordering parts for a shock-protecting device, make certain to specify its exact type. For further details of the description and numbering of spare parts, see the "Technological Dictionary of Watch Parts", 2nd edition, published by Ebauches S. A.

Order repair parts through your jobber, giving the numbers and designations, thus insuring prompt and efficient deliveries.